

PREMIUM QUALITY

# Never Paint Again!

# Custom Designed Railings



*"The team at AlumaRail are Great! Best products, Great selection and choice of colours, and the installers are True Craftsmen doing the best job possible. Once it's installed there is no maintenance ever. For all of our projects we always use AlumaRail; they do it Right and they do it on time."*

Frank Casamatta  
Greycliff Homes

Tel: 905-264-6400  
Toll Free: 1-877-258-6288  
Fax: 905-851-9138

[www.alumarail.com](http://www.alumarail.com)

Call for a **FREE** Estimate  
or Come Visit  
our Showroom

Ask about our  
Do-It-Yourself Program

FEATURED ON

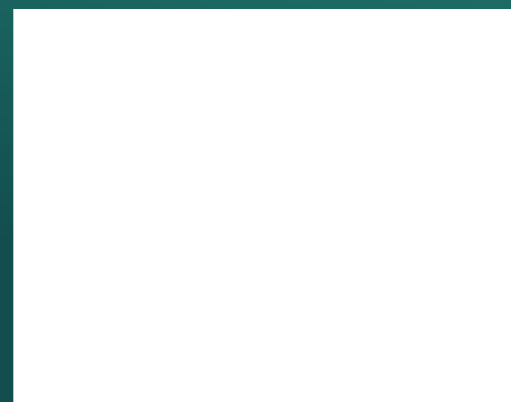

## PRODUCT CATALOG

RAILINGS • COLUMNS • FENCES  
GATES & MORE

[www.alumarail.com](http://www.alumarail.com)





**Alumarail Manufacturing Inc.** has been in the aluminum business since 1983, providing maintenance free aluminum for homes and special projects. Specializing in aluminum railings for your home or business, custom made to satisfy your requirements. We manufacture aluminum railings, gates, fences, columns, in a variety of styles and colours. We strive to be the leader in quality aluminum products and continue to exceed every customers expectations. All our railings meet the Ontario Building Code.

With an aluminum railing from Alumarail you get the beauty of wrought iron without the hassle... Railings that are maintenance free and never rust. What's more you get the expertise, commitment and customer satisfaction that comes with a company that has been in business for over 25 years.

Alumarail uses the finest aluminum extrusion company in the GTA, not galvanized steel, to ensure you will be happy with the installation many years from now, guaranteed. We will discuss the colour and style of railings, columns and gates that you want. Then precise measurements are taken to ensure a perfect fit. An estimate is prepared for your consideration and approval.

With your go ahead, we will custom manufacture your railings. The pieces are then painted to your exact specifications. The colours are baked, not powder-coated, to ensure a lasting, UV resistant finish. The crew then arrives for the removal and disposal of any existing railings and the installation of your new ones. The end result is a home transformed, one that strictly adheres to federal and provincial building codes, with the area so clean you won't know that anyone had been there.

If you want to save some money on installation and do it yourself, Alumarail will instruct you on the proper techniques. We also do new custom-built homes and subdivisions.

If you want to transform the look of your home and reduce maintenance, call Alumarail today for a free estimate or drop by our showroom.

## Our beautiful line up of products are ideal for:

- Residential
- Renovation/Restoration
- Pool enclosures/Decks
- Low Rise/Buildings
- Property Fences
- Cottages
- Boat Houses
- Retaining Walls
- Restaurants
- Commercial Establishments
- Deck/Patio Enclosures

### NEW - High Rise Buildings





## Colour Palette

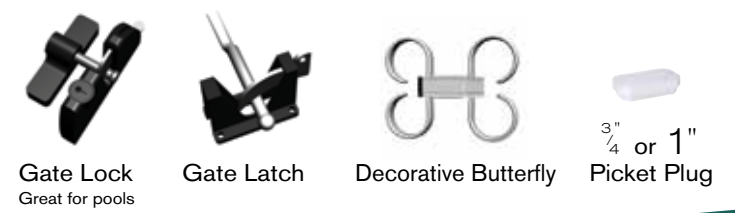
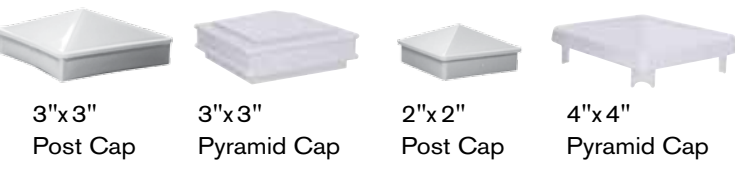
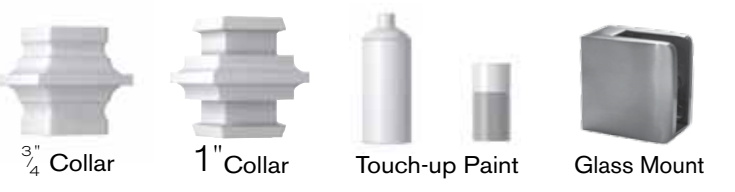
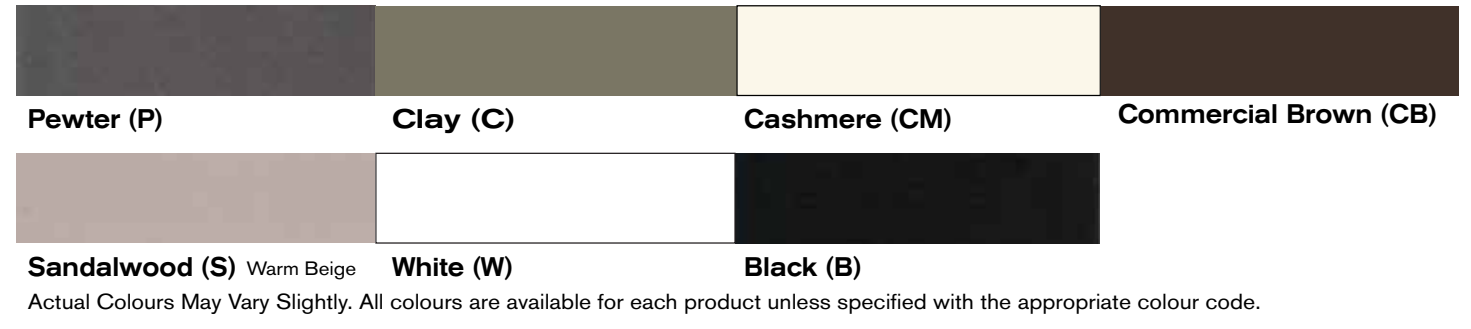

## Pickets | Posts

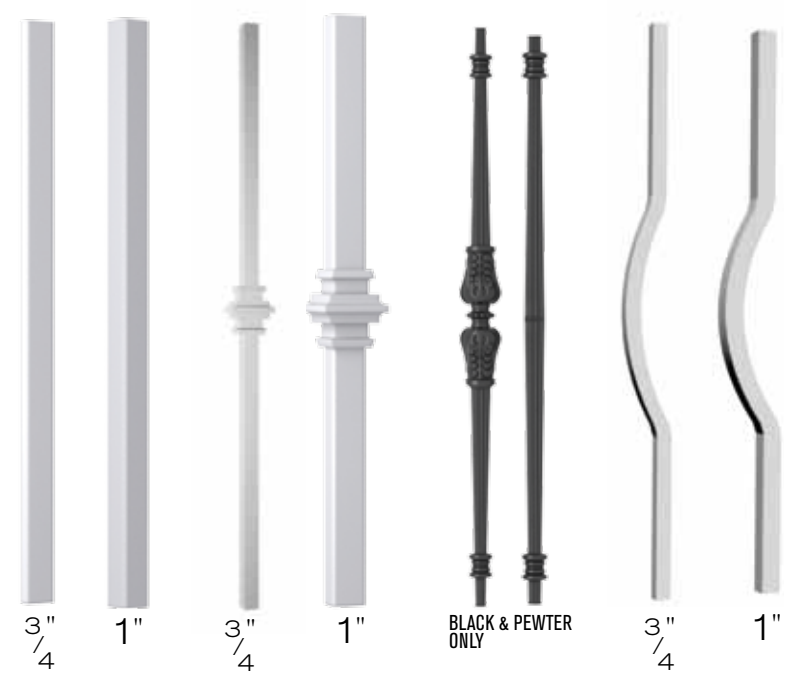

# Columns

Load bearing

# Smooth Columns

Tops and Bases are available in 1 Piece or 2 Piece designs.  
- Seven Standard Colours

# Double Columns

Available in 2"x2" and 3"x3" posts  
Styles of Railing between posts can be R1 to R20

# Privacy Panels



FLUTED



4" X 4" SQUARE

5 1/4" X 5 1/4" SQUARE

7 1/4" ROUND

7 1/4" X 7 1/4" SQUARE

SMOOTH

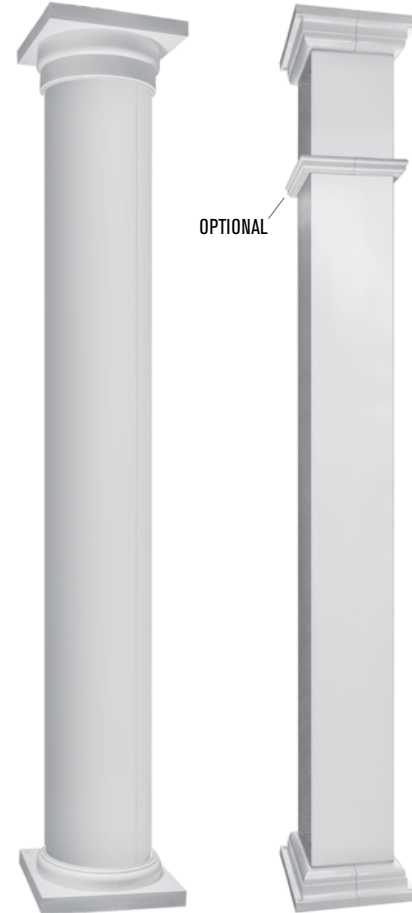

8" ROUND

7 1/4" X 7 1/4" SQUARE

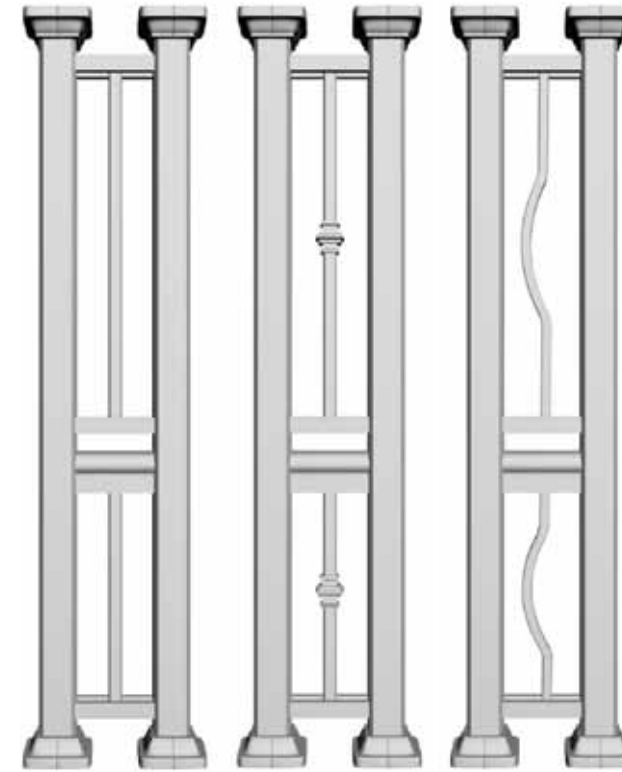

DC1

DC2

DC3

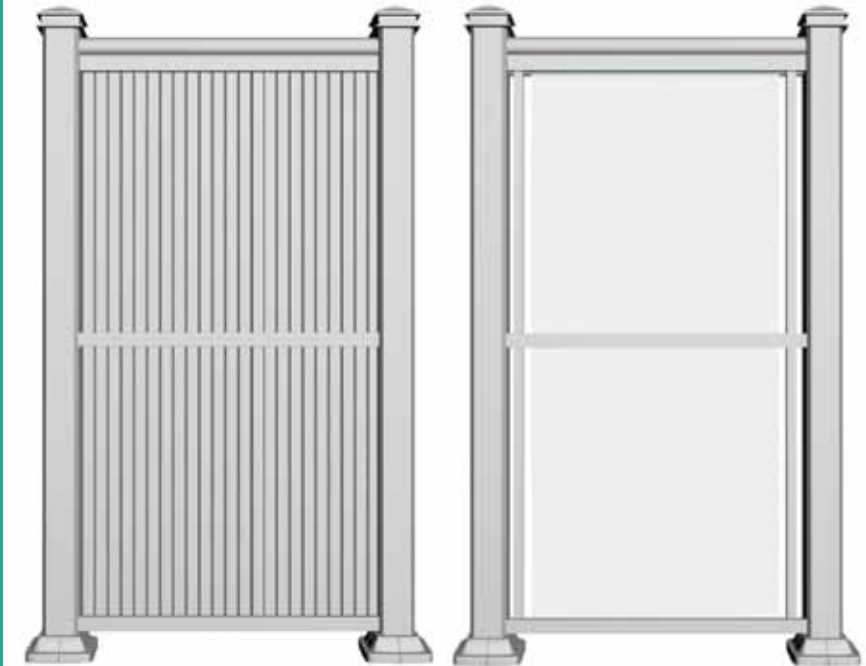

PP1 ALUMINUM

PP2 TEMPERED GLASS



# Railings

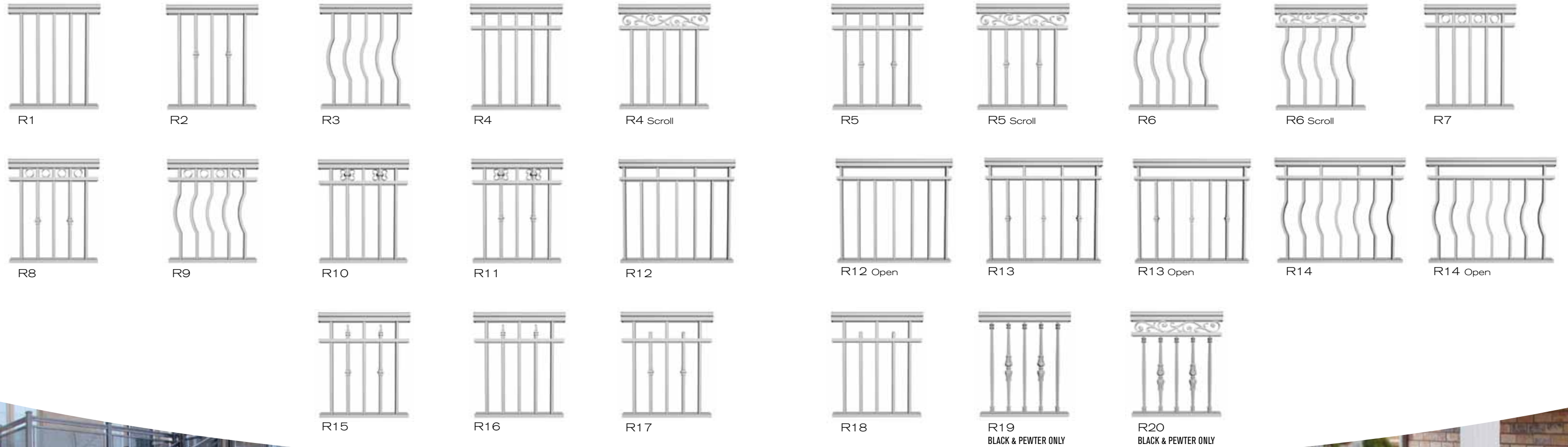

# Glass Railings



Glass available in:  
 Clear  
 Smoked grey  
 Bronze  
 Frosted



GR1



GR2



GR3

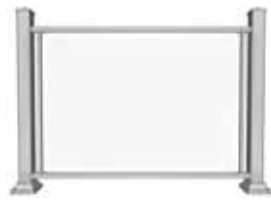

GR4



GR5



GR6



GRF1



GRF2

# Decor Railings

Available in 18" or 24" height



D1

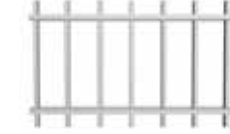

D2



D3

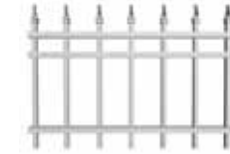

D4

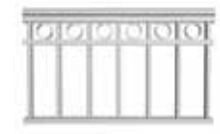

D5



D6

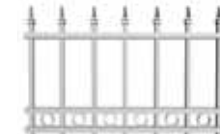

D7



D8



D9

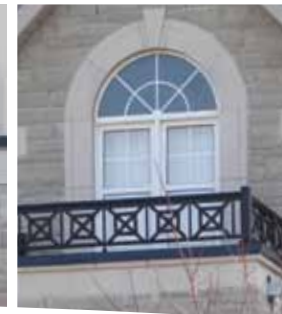

# Platinum Series



Top Rail



Platinum

Picket

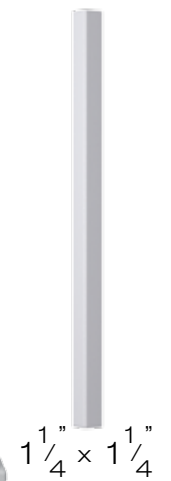

Posts



	<b>White (W)</b>
	<b>Black (B)</b>
	<b>Cashmere (CM)</b>
	<b>Clay</b>
	<b>Sandalwood (S)</b> Warm Beige
	<b>Commercial Brown (CB)</b>

Actual Colours May Vary Slightly.  
 All colours are available for each product unless specified with the appropriate colour code.

# Fences

Matching Gates Available for F1 to F8  
Available in 3/4" or 1" pickets

# Gates

Available in 3/4" or 1" pickets  
Gates can be made with pyramid top or straight top



F1



F2



F3

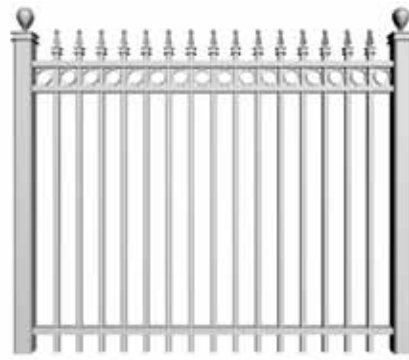

F4

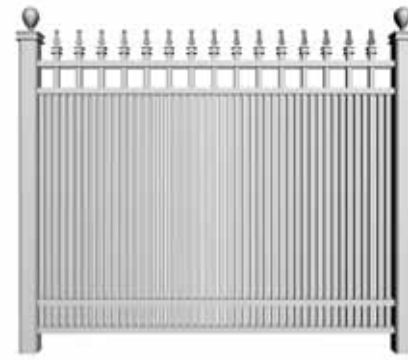

F7

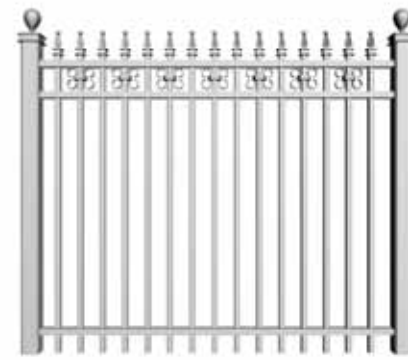

F8

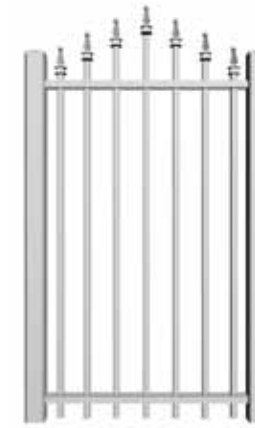

F1 Gate

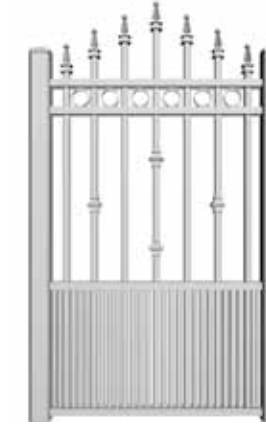

G1



G2

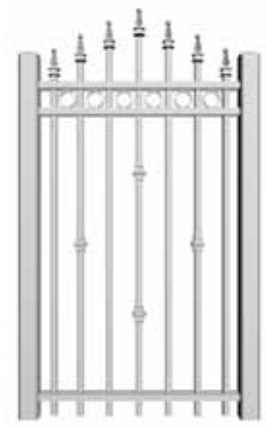

G3



F2 Gate



G4

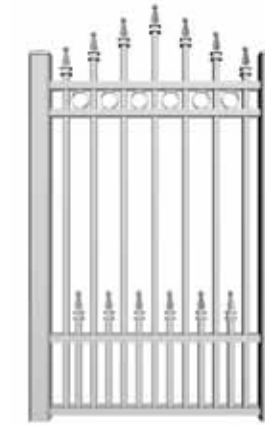

G5

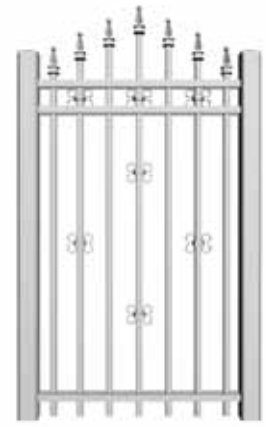

G6



# Mid Rise, High Rise & Multi-Unit Residential

# Commercial

